

Upper Front Fender Apron Seal

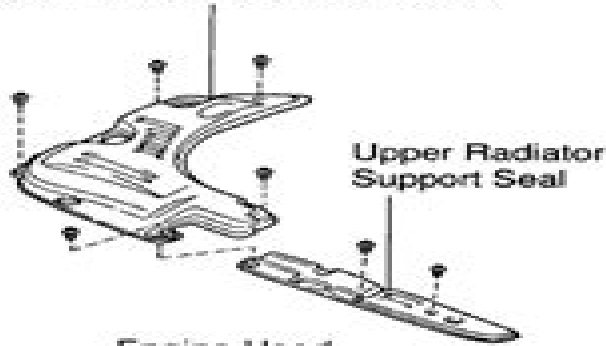

Upper Radiator Support Seal

Engine Hood

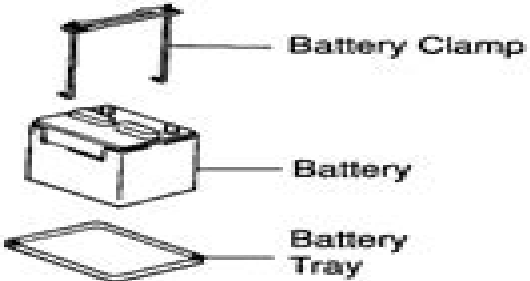
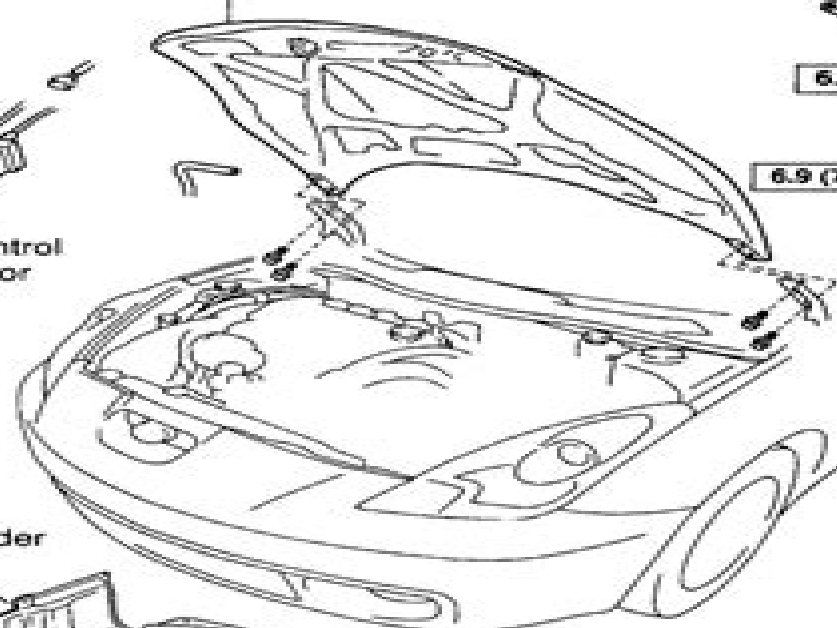

Battery Clamp

Battery

Battery Tray

6.9 (70, 61 in.-lbf)

6.9 (70, 61 in.-lbf)

ECM Box Cover

ECM Box

12 (120, 9)

ECM Box Stay

18 (185, 13)

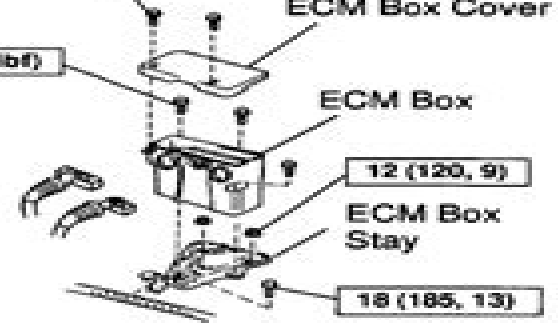

Cruise Control Accumulator

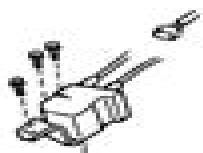

RH Engine Under Cover

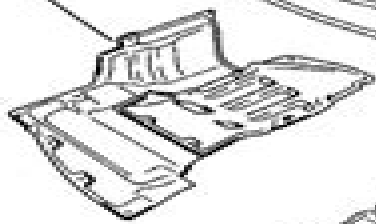

LH Engine Under Cover

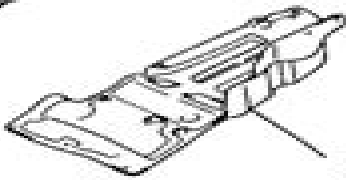

VSV for EVAP



Air Cleaner Cap



5.0 (51, 44 in.-lbf)

Air Filter



Air Cleaner Case



N·m (kgf·cm, ft·lbf) : Specified torque

# Engine Diagram For 1994 Toyota Celica

**LM Reder**



# Engine Diagram For 1994 Toyota Celica

United States/Japan Auto Parts Trade United States. Congress. Senate. Committee on Small Business. Subcommittee on Innovation, Technology, and Productivity,1990 **Autocar & Motor** ,1994-07 **Lear's** ,1993 *Five Marys Family Style* Mary Heffernan,Jess Thomson,2022-09-27 Following up on her popular cookbook Five Marys Ranch Raised Mary Heffernan reveals family life on the ranch through the traditions crafts and meals they share together throughout the year I want to make everything from this cookbook Tieghan Gerard Half Baked Harvest Arranged around 17 themed menus for favorite family events and activities Five Marys Family Style takes the reader on a journey through the seasons and customs that drive life on the ranch Featuring more than 75 rustic hearty recipes inside readers will discover the Heffernan family s Thanksgiving and Christmas traditions menus for a cozy fireside dinner a summer cookout a pack ahead picnic or an end of week taco fiesta Sprinkled throughout the book are simple crafty DIY projects that Mary and her four daughters have fun making together including indigo dyed tea towels flower filled holiday table runners and hand rolled beeswax candles Along the way Mary shares stories of life on the ranch as well as the faithful traditions and strong connections she maintains with her extended family Lush photography captures the expansive beauty of the ranch the animals including dogs cats and horses and of course Mary and her beloved husband and ranching co partner Brian This is the definition of simple fun and beautiful food Giddyup and start cookin Al Roker *The Used Car Book, 1994* Jack Gillis,1994-05 Provides a wealth of consumer oriented information on approximately 160 used cars and minivans This guide contains full page entries that cover 10 years of each model with a summary and easy to read chart listing fuel economy maintenance costs current prices and much more Many helpful features *F & S Index International Annual* ,1995 *Supercharging, Turbocharging and Nitrous Oxide Performance* Earl Davis, This is a complete guide to selecting installing and tuning forced induction fuel air systems Everything involved with these systems will be covered including assessing power goals component selection engine preparation tools installation procedures tuning vehicle modifications driveability and sources **Cars & Parts** ,1994 **The Automobile Industry, Toyota and Japan** ,1995 **Road and Track** ,1993 **Japanese Motor Business** ,1995 A research bulletin examining the Japanese automotive industry s impact worldwide The Automobile Industry, Japan and Toyota ,1995 **Lemon-aid Car Guide 2001** Phil Edmonston,2001 A guide to buying a used car or minivan features information on the strengths and weaknesses of each model a safety summary recalls warranties and service tips *Autocar* ,1999 *The Toyota Way* Jeffrey K. Liker,2003-12-22 How to speed up business processes improve quality and cut costs in any industry In factories around the world Toyota consistently makes the highest quality cars with the fewest defects of any competing manufacturer while using fewer man hours less on hand inventory and half the floor space of its competitors The Toyota Way is the first book for a general audience that explains the management principles and business philosophy behind

Toyota's worldwide reputation for quality and reliability Complete with profiles of organizations that have successfully adopted Toyota's principles this book shows managers in every industry how to improve business processes by Eliminating wasted time and resources Building quality into workplace systems Finding low cost but reliable alternatives to expensive new technology Producing in small quantities Turning every employee into a quality control inspector Automotive Mechatronics: Operational and Practical Issues B. T. Fijalkowski, 2010-11-25 This book presents operational and practical issues of automotive mechatronics with special emphasis on the heterogeneous automotive vehicle systems approach and is intended as a graduate text as well as a reference for scientists and engineers involved in the design of automotive mechatronic control systems As the complexity of automotive vehicles increases so does the dearth of high competence multi-disciplined automotive scientists and engineers This book provides a discussion into the type of mechatronic control systems found in modern vehicles and the skills required by automotive scientists and engineers working in this environment Divided into two volumes and five parts Automotive Mechatronics aims at improving automotive mechatronics education and emphasises the training of students experimental hands on abilities stimulating and promoting experience among high education institutes and produce more automotive mechatronics and automation engineers The main subject that are treated are VOLUME I RBW or XBW unibody or chassis motion mechatronic control hypersystems DBW AWD propulsion mechatronic control systems BBW AWB propulsion mechatronic control systems VOLUME II SBW AWS diversion mechatronic control systems ABW AWA suspension mechatronic control systems This volume was developed for undergraduate and postgraduate students as well as for professionals involved in all disciplines related to the design or research and development of automotive vehicle dynamics powertrains brakes steering and shock absorbers dampers Basic knowledge of college mathematics college physics and knowledge of the functionality of automotive vehicle basic propulsion propulsion conversion and suspension systems is required Popular Science, 1994-12 Popular Science gives our readers the information and tools to improve their technology and their world The core belief that Popular Science and our readers share The future is going to be better and science and technology are the driving forces that will help make it better *Subject Guide to Children's Books in Print 1997* Bowker Editorial Staff, R R Bowker Publishing, 1996-09 *Encyclopedia of Renewable and Sustainable Materials*, 2020-01-09 Encyclopedia of Renewable and Sustainable Materials Five Volume Set provides a comprehensive overview covering research and development on all aspects of renewable recyclable and sustainable materials The use of renewable and sustainable materials in building construction the automotive sector energy textiles and others can create markets for agricultural products and additional revenue streams for farmers as well as significantly reduce carbon dioxide CO2 emissions manufacturing energy requirements manufacturing costs and waste This book provides researchers students and professionals in materials science and engineering with tactics and information as they face increasingly complex challenges around the development selection and use of construction and manufacturing materials

Covers a broad range of topics not available elsewhere in one resource Arranged thematically for ease of navigation  
Discusses key features on processing use application and the environmental benefits of renewable and sustainable materials  
Contains a special focus on sustainability that will lead to the reduction of carbon emissions and enhance protection of the natural environment with regard to sustainable materials *Federal Register* ,1994-06-16

28 books pewdiepie recommended read this twice - Jul 07 2022

web apr 22 2004 updated 2022 the most up to date and comprehensive list of 28 verified book recommendations from pewdiepie includes quotes and sources

*pewdiepie shelf goodreads* - Jan 13 2023

web lists pewds recomended 33 books 1 voter pewdiepie book review 44 books 4 voters pewdiepie s literature club 85 books 155 voters pewdiepie genre new releases and popular books including american psycho by bret easton ellis kafka on the shore by haruki murakami the dice man by l

**pewdiepie graphic novel 9781405924047 abebooks** - Oct 10 2022

web pewdiepie is the next julius caesar william shakespeare jrr tolkien and taylor swift all in one person this piece will remove world hunger poverty and my virginity fan feedback

this book loves you by pewdiepie goodreads - Sep 21 2023

web oct 20 2015 this book loves you by pewdiepie is a collection of beautifully illustrated inspirational sayings by which you should live your life if you follow each and every one your life will become easier more fabulous more rewarding

*pewdiepie projects photos videos logos illustrations and* - Jun 06 2022

web pewdiepie creative fields creative fields popular all creative fields architecture art direction branding fashion graphic design illustration industrial design interaction design motion graphics photography ui ux web design alphabetical 3d art 3d modeling 3d motion a advertising advertising photography animation app design apparel ar vr

*pewdiepie graphic novel by pewdiepie felix kjellberg* - Apr 04 2022

web novel readings au pewdiepie no longer the richest r in the world unilad pewdiepie graphic novel by penguin ic book release pewdiepie graphic novel pewdiepie 9781405932219 at scott pilgrim vs the world pewdiepie graphic novel

knihcentrum cz pewdiepie 10 highest earning rs revealed

amazon com this book loves you 9781101999042 pewdiepie - Oct 22 2023

web oct 20 2015 the instant 1 new york times bestseller from the mind of pewdiepie the 1 youtuber in the world with 40 million fans and more than 10 billion views comes this book loves you a collection of beautifully illustrated inspirational thoughts and sayings

*pewdiepie graphic novel pewdiepie google books* - Jul 19 2023

web bibliographic information title pewdiepie graphic novel author pewdiepie publisher penguin books limited 2017 isbn 1405924047 9781405924047

**pewdiepie s literature club 85 books goodreads** - Aug 20 2023

web mar 4 2018 listopia pewdiepie s literature club book s talked by felix in his videos starting 2018 playlist with the book reviews youtube playlist flag all votes add books to this list 85 books 155 voters list created march 3rd 2018 by maria votes

**pewdiepie books goodreads** - Sep 09 2022

web books shelved as pewdiepie american psycho by bret easton ellis kafka on the shore by haruki murakami the dice man by luke rhinehart the sailor who f

**pewdiepie open library** - Nov 11 2022

web jul 14 2020 pewdiepie graphic novel by pewdiepie first published in 2017 1 edition in 1 language not in library subjects american wit and humor

**41 pewdiepie book recommendations bookshop org** - Dec 12 2022

web 41 pewdiepie book recommendations

**pewdiepie penguin books australia** - Feb 14 2023

web pewdiepie pewdiepie com pewdiepie is one of the most popular youtuber s in the world with millions of subscribers generating billions of views he is swedish and lives in brighton pewdiepie was sent to planet earth to dispense wisdom teach us common sense and instruct us in the ancient art of inspirology

*43 pewdiepie book recommendations all books most* - Apr 16 2023

web not at all the beauty of a book recommendations list is that it allows you to choose books that align with your interests and the time you have available for reading however each book on pewdiepie s list offers a unique insight into his life and personality whether he s acting as a comedian designer a designer educator or simply a book lover

*pewdiepie author of this book loves you goodreads* - Aug 08 2022

web oct 24 1989 website born as felix arvid ulf kjellberg on 24 october 1989 sweden better known by his online alias pewdiepie is a swedish producer of lets play videos on youtube on 15 august 2013 pewdiepie s channel became the most subscribed channel on youtube being surpassed briefly in november and december 2013 by youtube s

**pewdiepie graphic novel pewdiepie 9781405924047** - Jun 18 2023

web pewdiepie graphic novel pewdiepie on amazon com au free shipping on eligible orders pewdiepie graphic novel

**pewdiepie book lists goodreads** - Mar 15 2023

web 33 books 1 voter lists about pewdiepie s literature club pewdiepie book review and pewds recommended

*pewdiepie graphic novel pewdiepie 9781405924047* - May 17 2023

web oct 31 2018 join pewdiepie and his beloved dog edgar as they work their way through a series of hilarious and terrifying encounters in this his first graphic novel

**pewdiepie graphic novel by penguin comic book release** - May 05 2022

web pewdiepie graphic novel by penguin year 2017 code 9781405924047 language english authors pewdiepie genre graphic novel notes release imported from british library public domain license

**pewdiepie lets play tv tropes** - Mar 03 2022

web felix arvid ulf kjellberg b october 24 1989 better known as pewdiepie is a swedish youtuber known for his gaming content and comedic formatted videos and shows

**die welt ist ein schöner ort der weg meiner tocht japanalert** - May 08 2022

die welt ist ein schöner ort der weg meiner tocht 3 3 südtirol ironisch schelmisch erhellend der klassiker der südtirol literatur die schöne welt ist südtirol das 1919 von Österreich zu italien kam zu der zeit da gatterers erzählung einsetzt hat sich die jahrhundertealte bäuerliche welt scheinbar mit dem neuen staat und seinen

melissa naschenweng die welt is so a schöner ort songtext - Feb 17 2023

die welt is so a schöner ort songtext von melissa naschenweng mit lyrics deutscher Übersetzung musik videos und liedtexten kostenlos auf songtexte com

**die welt ist ein schöner ort der weg meiner tocht pdf** - Sep 24 2023

die schöne welt ist südtirol das 1919 von Österreich zu italien kam zu der zeit da gatterers erzählung einsetzt hat sich die jahrhundertealte bäuerliche welt scheinbar mit

**die welt ist ein schöner ort der weg meiner tocht download** - Sep 12 2022

die welt ist ein schöner ort der weg meiner tocht die welt ist ein schöner ort schöne müllerin uncanny x men 1 schöne neue welt die familie mendelssohn 1729 1847 th die idee des schönen das schöne in natur und geist der kunststoff das schöne in der kunst 2 th die bildende kunst die musik die poesie

**der weg der freiheit song and lyrics by welse im weltall spotify** - Oct 13 2022

listen to der weg der freiheit on spotify welse im weltall song 2021 welse im weltall song 2021 listen to der weg der freiheit on spotify welse im weltall song 2021 sign up log in home search your library create your first playlist it s easy we ll help

**die welt ist ein schöner ort der weg meiner tocht peter m daly** - Mar 18 2023

die welt ist ein schöner ort deborah ziegler 2017 03 20 so bin ich eben juliette grco 2012 09 24 die grande dame des franzsischen chansons erzht ihr leben juliette grcos leben ist ein roman als sie 16 ist werden ihre mutter ein mitglied der rsistance und ihre schwester ins kz deportiert juliette kommt nur in ein frauengefngnis

*die welt ist ein schoner ort der weg meiner tocht uniport edu* - Dec 15 2022

das schöne mädchen von perth sir walter scott 2012 die serie meisterwerke der literatur beinhaltet die klassiker der deutschen und weltweiten literatur in die welt ist ein schoner ort der weg meiner tocht 2 5

*die welt ist ein schoner ort der weg meiner tocht full pdf* - Feb 05 2022

die welt ist ein schoner ort der weg meiner tocht schöne wilde welt die welt berühmte sehr alte schöne am ligustischen meer ligende hauptstadt und mächtige republic genua

**die welt ist ein schöner ort der weg meiner tochter in einen** - Apr 19 2023

mar 20 2017 es beginnt ein zäher kampf doch sie findet einen weg elf monate nach der diagnose nimmt sie ein tödliches medikament zu sich und stirbt in oregon umringt von familie und freunden in ihrem buch erzählt brittanys mutter von dem unglaublichen mut ihrer tochter und von ihrem beispiellosen einsatz für einen würdevollen tod

[die welt ist ein schoner ort der weg meiner tocht uniport edu](#) - Mar 06 2022

may 1 2023 die welt ist ein schoner ort der weg meiner tocht recognizing the way ways to get this books die welt ist ein schoner ort der weg meiner tocht is additionally useful you have remained in right site to start getting this info get the die welt ist ein schoner ort der weg meiner tocht partner that we meet the expense of here and check out the link

[die welt ist ein schoner ort der weg meiner tocht pdf](#) - Jul 10 2022

die welt ist ein schoner ort der weg meiner tocht downloaded from eagldemo2 eagltechnology com by guest malaki hamilton die familie mendelssohn 1729 1847 bod books on demand eine kindheit unter dem faschismus in südtirol ironisch schelmisch erhellend der klassiker der südtirol literatur die schöne welt ist südtirol das

*die welt ist ein schoner ort der weg meiner tocht copy* - Aug 11 2022

die welt ist ein schoner ort der weg meiner tocht 3 3 sachkundig gemachten büchlein über beide viel erfahren die stadt und den dichter schrieb die zeit über die erstausgabe die welt ist ein schöner ort university of chicago press die serie meisterwerke der literatur beinhaltet die klassiker der deutschen und

[die welt ist ein schoner ort der weg meiner tocht copy ftp](#) - Jan 16 2023

2 die welt ist ein schoner ort der weg meiner tocht 2019 12 29 examines müller s permutation of the literary legends as an exploration of erotic obsession delusion frenzy disillusionment and death and the way in which schubert crucially altered müller s vision when the poetic cycle became a musical text

**die welt ist ein schöner ort der weg meiner tochter in einen** - Jun 09 2022

die welt ist ein schöner ort der weg meiner tochter in einen würdevollen tod ziegler deborah kemper eva amazon de bücher bücher ratgeber psychologie hilfe neu 9 50 preisangaben inkl ust abhängig von der lieferadresse kann die ust an der kasse variieren weitere informationen lieferung für 2 99 6 11 april details



**die welt ist ein schoener ort der weg meiner tocht uniport edu** - Apr 07 2022

die welt ist ein schoener ort der weg meiner tocht 1 8 downloaded from uniport edu ng on october 5 2023 by guest die welt ist ein schoener ort der weg meiner tocht this is likewise one of the factors by obtaining the soft documents of this die welt ist ein schoener ort der weg meiner tocht by online

**die welt ist ein schöner ort der weg meiner tochter in einen** - Jul 22 2023

die welt ist ein schöner ort der weg meiner tochter in einen würdevollen tod kindle ausgabe von deborah ziegler autor eva kemper Übersetzer format kindle ausgabe 265 sternbewertungen alle formate und editionen anzeigen

**die zukunft ist ein einsamer ort trailer german** - Nov 14 2022

jul 29 2022 offizieller die zukunft ist ein einsamer ort trailer deutsch german 2022 abonnieren abo yt kc ot die zukunft ist ein einsamer ort movie t

*die welt ist ein schoener ort der weg meiner tocht full pdf* - Aug 23 2023

die welt ist ein schoener ort der weg meiner tocht g von peschwitz jüngst erbauter hoch teutscher parnass das ist anmuthige formeln sinnreiche poetische beschreibungen und kunstzierliche verblühte arten zu reden aus den besten poeten unserer zeit zusammen getragen etc with a preface by j p titz apr 13 2021

**ebook die welt ist ein schoener ort der weg meiner tocht** - May 20 2023

die welt ist ein schoener ort der weg meiner tocht the concept of correlation dec 23 2021 die traditionen des menschengeschlechts oder die uroffenbarung gottes unter den heiden jul 18 2021 offene räume mar 06 2023 this book collects designs for 21 locations in the stuttgart region results of an international workshop joh

downloadable free pdfs die welt ist ein schoener ort der weg meiner tocht - Jun 21 2023

die welt ist ein schoener ort der weg meiner tocht reisen und entdeckungen in nord und central afrika in den jahren 1849 bis 1855 aug 16 2022 joh amos comenii orbis sensualium pictus quadrilinguis hoc est omnium fundamentalium in mundo rerum et in vita actionum pictura et nomenclatura germanica latina italica et gallica etc mar 31

türkiye nin en eski kütüphaneleri bilginin tarihine yolculuk - Mar 30 2022

web oct 27 2020 milli kavramının ön plana çıktığı ii meşrutiyet yıllarında türklerin de ulusal bir kütüphanesinin olması gerektiği fikri ön plana çıktı 1911 yılında bu fikrin öncüleri kütüphanenin kurulmasına yönelik ilk çalışmaları başlattı

chronik bibliothek des 20 jahrhunderts 1908 1911 band 3 amazon de - Jun 13 2023

web chronik bibliothek des 20 jahrhunderts 1908 1911 band 3 isbn 9783577171830 kostenloser versand für alle bücher mit versand und verkauf duch amazon

**chronik bibliothek des 20 jahrhunderts 1908 1911 band 3 by** - Nov 06 2022

web 20 21 1908 1911 chronik bibliothek des 20 jahrhunderts 3 jahr 1908 geboren vor 112 jahren geboren am chronik

thailands 1906 rama v alois payer pdf langenscheidt

*chronik bibliothek des 20 jahrhunderts 1908 1911* - Dec 27 2021

web mit einschluss der syrischen literatur des vierten jahrhunderts 1 und 2 aufl otto bardenhewer 1924 chronik bibliothek des 20 jahrhunderts 3 1908 1911 anonymus ac01755154 1995 international catalogue of scientific literature 1903 person und artefakt linus möllenbrink 2020 11 09

**kütüphanedeki tarih anisa manga** - Jan 28 2022

web 2 sezon 20 bölüm temmuz 8 2022 monkie kid 1 sezon 4 bölüm temmuz 5 2022 1 sezon 3 bölüm temmuz 5 2022 ankara escort bonus veren siteler deneme bonusu veren siteler casino siteleri canlı casino 2019 2021 anisamanga tüm hakları saklıdır giriş yap

**chronik bibliothek des 20 jahrhunderts 1908 1911** - Dec 07 2022

web chronik bibliothek des 20 jahrhunderts 1908 1911 chronik bibliothek des 20 jahrhunderts 1908 1911 2 downloaded from darelova com on 2023 01 15 by guest verschiedenen perspektiven und mit den methoden jüngerer forschungsansätze werden standpunkte und blickwinkel des chronisten fassbar insgesamt wird der enorme wert der

*chronik bibliothek des 20 jahrhunderts 1908 picclick de* - Oct 05 2022

web jahrhunderts 1908 1911 buch zustand gut eur 13 69 zu verkaufen geprüfte second hand artikel certified second hand articles Über 4 385483450408

**chronik bibliothek des 20 jahrhunderts booklooker** - May 12 2023

web chronik bibliothek des 20 jahrhunderts 1908 1911 band 3 meiners fischer u a chronik verlag im bertelsmann lexikon verlag 1996 kunstleder zustand wie neu

**chronik bibliothek des 20 jahrhunderts chronik 1911** - Apr 11 2023

web liste der neuzugänge sammlungsgut aus kolonialen kontexten ddbpro das portal für datenpartner die kultursuchmaschine aktuell 51 226 619 objekte standard standard suche erweitert erweiterte suche stöbern suche in objekte personen organisationen themen

**chronik bibliothek des 20 von bertelsmann zvab** - Feb 09 2023

web chronik bibliothek des 20 jahrhunderts 1900 1999 registerband von die große bertelsmann lexikothek und eine große auswahl ähnlicher bücher kunst und sammlerstücke erhältlich auf zvab com

**chronik bibliothek des 20 jahrhunderts 1908 1911 band 3 by** - Aug 03 2022

web kunst schülerlexikon chronik bibliothek des 20 jahrhunderts 1908 1911 chronik bibliothek des 20 jahrhunderts series chronik des 20 jahrhundert was war wann pressearchive 20 jahrhundert psfnac faudiovisual com 3 31

*bibliothek der nation wikipedia* - Jun 01 2022

web die bibliothek der nation ist seit der gründung der türkischen republik die größte bibliothek des landes im besitz der bibliothek befindet sich eine ausgabe des ersten türkischen wörterbuchs dîvânul lugâti t türk des mahmûd al kâschgharî die bibliothek hat eine fläche von 125 000 m<sup>2</sup> und kann 5 500 leser aufnehmen

*chronik bibliothek des 20 jahrhunderts band 3 1908 1911 - Aug 15 2023*

web chronik bibliothek des 20 jahrhunderts 1908 1911 band 3 finden sie alle bücher von dr richard miklin bei der büchersuchmaschine eurobuch com können sie antiquarische und neubücher vergleichen und sofort zum bestpreis bestellen 357717143x ed hardcover gebunden pu bertelsmann lexikon

**chronik bibliothek des 20 jahrhunderts 1908 1911 band 3 ebay - Jul 02 2022**

web entdecken sie chronik bibliothek des 20 jahrhunderts 1908 1911 band 3 in der großen auswahl bei ebay kostenlose lieferung für viele artikel

**İstanbul un en bilinen 5 kütüphanesi independent türkçe - Feb 26 2022**

web mar 27 2019 1884 te kurulan beyazıt devlet kütüphanesi İstanbul un en köklü kütüphanelerinden türkiye nin devlet eliyle kurulan ilk kütüphanesi yaklaşık 135 yıldır hizmet veriyor ve günümüzde 1 milyonu aşkın dokümanla arşivi en zengin kütüphanelerarasında gösteriliyor kütüphane i umumi i osmani ismiyle kurulan

cumhuriyet dönemi İstanbul kütüphaneleri - Apr 30 2022

web yaklaşık 40 yıl önceki İstanbul un kütüphane haritasını sunan bu kitaba göre İstanbul da aşağıdaki başlıklarda toplam 379 kütüphane bulunmaktadır halk kütüphaneleri 66 adet hastahane kütüphaneleri 20 adet müze ve yazma eser kütüphaneleri 15 adet sanayi ticaret ve meslek kuruluşları kütüphaneleri 38 adet

chronik bibliothek des 20 jahrhunderts 1908 1911 band 3 amazon de - Jul 14 2023

web chronik bibliothek des 20 jahrhunderts 1908 1911 band 3 isbn 9783577171434 kostenloser versand für alle bücher mit versand und verkauf duch amazon

**chronik bibliothek des 20 jahrhunderts 1908 1911 pdf full pdf - Mar 10 2023**

web insgesamt wird der enorme wert der bislang nur im hinblick auf einzelne elemente ausgeschöpften chronik für ein verständnis der lebenswirklichkeit des 13 jahrhunderts im königreich sizilien deutlich nürnbergiger künstlerlexikon nürnberg tätig waren vermitteln eine beeindruckende tradition

9783577171434 chronik bibliothek des 20 jahrhunderts 1908 1911 - Sep 04 2022

web chronik bibliothek des 20 jahrhunderts 1908 1911 band 3 finden sie alle bücher von dr richard miklin bei der büchersuchmaschine eurobuch ch können sie antiquarische und neubücher vergleichen und sofort zum bestpreis bestellen 9783577171434 ean 9783577171434 befriedigend good durchschnittlich

*chronik bibliothek des 20 jahrhunderts 1908 1911 band 3 by - Jan 08 2023*

web berühmte literaten geboren am chronik bibliothek des 20 jahrhunderts 1908 1911 20 jahrhundert die chronik des 20 und 21 jahrhunderts jetzt online lemo jahreschronik chronik 1901 chronik bibliothek des 20 jahrhunderts 2001 von n a bibliothek uniq werbeagentur chronik des 19

If you ally dependence such a referred **Engine Diagram For 1994 Toyota Celica** book that will manage to pay for you worth, get the unquestionably best seller from us currently from several preferred authors. If you want to witty books, lots of novels, tale, jokes, and more fictions collections are after that launched, from best seller to one of the most current released.

You may not be perplexed to enjoy every books collections Engine Diagram For 1994 Toyota Celica that we will extremely offer. It is not re the costs. Its about what you obsession currently. This Engine Diagram For 1994 Toyota Celica, as one of the most operational sellers here will certainly be accompanied by the best options to review.

[https://offsite.creighton.edu/files/virtual-library/Documents/mark\\_d\\_eddy\\_mission\\_president.pdf](https://offsite.creighton.edu/files/virtual-library/Documents/mark_d_eddy_mission_president.pdf)

[https://offsite.creighton.edu/files/virtual-library/Documents/manager\\_transition\\_plan\\_template.pdf](https://offsite.creighton.edu/files/virtual-library/Documents/manager_transition_plan_template.pdf)

[https://offsite.creighton.edu/files/virtual-library/Documents/maps\\_that\\_lie.pdf](https://offsite.creighton.edu/files/virtual-library/Documents/maps_that_lie.pdf)

## **Table of Contents Engine Diagram For 1994 Toyota Celica**

1. Understanding the eBook Engine Diagram For 1994 Toyota Celica
  - The Rise of Digital Reading Engine Diagram For 1994 Toyota Celica
  - Advantages of eBooks Over Traditional Books
2. Identifying Engine Diagram For 1994 Toyota Celica
  - Exploring Different Genres
  - Considering Fiction vs. Non-Fiction
  - Determining Your Reading Goals
3. Choosing the Right eBook Platform
  - Popular eBook Platforms
  - Features to Look for in an Engine Diagram For 1994 Toyota Celica

- User-Friendly Interface
- 4. Exploring eBook Recommendations from Engine Diagram For 1994 Toyota Celica
  - Personalized Recommendations
  - Engine Diagram For 1994 Toyota Celica User Reviews and Ratings
  - Engine Diagram For 1994 Toyota Celica and Bestseller Lists
- 5. Accessing Engine Diagram For 1994 Toyota Celica Free and Paid eBooks
  - Engine Diagram For 1994 Toyota Celica Public Domain eBooks
  - Engine Diagram For 1994 Toyota Celica eBook Subscription Services
  - Engine Diagram For 1994 Toyota Celica Budget-Friendly Options
- 6. Navigating Engine Diagram For 1994 Toyota Celica eBook Formats
  - ePub, PDF, MOBI, and More
  - Engine Diagram For 1994 Toyota Celica Compatibility with Devices
  - Engine Diagram For 1994 Toyota Celica Enhanced eBook Features
- 7. Enhancing Your Reading Experience
  - Adjustable Fonts and Text Sizes of Engine Diagram For 1994 Toyota Celica
  - Highlighting and Note-Taking Engine Diagram For 1994 Toyota Celica
  - Interactive Elements Engine Diagram For 1994 Toyota Celica
- 8. Staying Engaged with Engine Diagram For 1994 Toyota Celica
  - Joining Online Reading Communities
  - Participating in Virtual Book Clubs
  - Following Authors and Publishers Engine Diagram For 1994 Toyota Celica
- 9. Balancing eBooks and Physical Books Engine Diagram For 1994 Toyota Celica
  - Benefits of a Digital Library
  - Creating a Diverse Reading Collection Engine Diagram For 1994 Toyota Celica
- 10. Overcoming Reading Challenges
  - Dealing with Digital Eye Strain
  - Minimizing Distractions
  - Managing Screen Time
- 11. Cultivating a Reading Routine Engine Diagram For 1994 Toyota Celica
  - Setting Reading Goals Engine Diagram For 1994 Toyota Celica

- Carving Out Dedicated Reading Time
- 12. Sourcing Reliable Information of Engine Diagram For 1994 Toyota Celica
  - Fact-Checking eBook Content of Engine Diagram For 1994 Toyota Celica
  - Distinguishing Credible Sources
- 13. Promoting Lifelong Learning
  - Utilizing eBooks for Skill Development
  - Exploring Educational eBooks
- 14. Embracing eBook Trends
  - Integration of Multimedia Elements
  - Interactive and Gamified eBooks

### **Engine Diagram For 1994 Toyota Celica Introduction**

Engine Diagram For 1994 Toyota Celica Offers over 60,000 free eBooks, including many classics that are in the public domain. Open Library: Provides access to over 1 million free eBooks, including classic literature and contemporary works. Engine Diagram For 1994 Toyota Celica Offers a vast collection of books, some of which are available for free as PDF downloads, particularly older books in the public domain. Engine Diagram For 1994 Toyota Celica : This website hosts a vast collection of scientific articles, books, and textbooks. While it operates in a legal gray area due to copyright issues, its a popular resource for finding various publications. Internet Archive for Engine Diagram For 1994 Toyota Celica : Has an extensive collection of digital content, including books, articles, videos, and more. It has a massive library of free downloadable books. Free-eBooks Engine Diagram For 1994 Toyota Celica Offers a diverse range of free eBooks across various genres. Engine Diagram For 1994 Toyota Celica Focuses mainly on educational books, textbooks, and business books. It offers free PDF downloads for educational purposes. Engine Diagram For 1994 Toyota Celica Provides a large selection of free eBooks in different genres, which are available for download in various formats, including PDF. Finding specific Engine Diagram For 1994 Toyota Celica, especially related to Engine Diagram For 1994 Toyota Celica, might be challenging as theyre often artistic creations rather than practical blueprints. However, you can explore the following steps to search for or create your own Online Searches: Look for websites, forums, or blogs dedicated to Engine Diagram For 1994 Toyota Celica, Sometimes enthusiasts share their designs or concepts in PDF format. Books and Magazines Some Engine Diagram For 1994 Toyota Celica books or magazines might include. Look for these in online stores or libraries. Remember that while Engine Diagram For 1994 Toyota Celica, sharing copyrighted material without permission is not legal. Always ensure youre either creating your own or obtaining them from legitimate sources that allow sharing and downloading.

Library Check if your local library offers eBook lending services. Many libraries have digital catalogs where you can borrow Engine Diagram For 1994 Toyota Celica eBooks for free, including popular titles. Online Retailers: Websites like Amazon, Google Books, or Apple Books often sell eBooks. Sometimes, authors or publishers offer promotions or free periods for certain books. Authors Website Occasionally, authors provide excerpts or short stories for free on their websites. While this might not be the Engine Diagram For 1994 Toyota Celica full book, it can give you a taste of the authors writing style. Subscription Services Platforms like Kindle Unlimited or Scribd offer subscription-based access to a wide range of Engine Diagram For 1994 Toyota Celica eBooks, including some popular titles.

### FAQs About Engine Diagram For 1994 Toyota Celica Books

**What is a Engine Diagram For 1994 Toyota Celica PDF?** A PDF (Portable Document Format) is a file format developed by Adobe that preserves the layout and formatting of a document, regardless of the software, hardware, or operating system used to view or print it. **How do I create a Engine Diagram For 1994 Toyota Celica PDF?** There are several ways to create a PDF: Use software like Adobe Acrobat, Microsoft Word, or Google Docs, which often have built-in PDF creation tools. Print to PDF: Many applications and operating systems have a "Print to PDF" option that allows you to save a document as a PDF file instead of printing it on paper. Online converters: There are various online tools that can convert different file types to PDF. **How do I edit a Engine Diagram For 1994 Toyota Celica PDF?** Editing a PDF can be done with software like Adobe Acrobat, which allows direct editing of text, images, and other elements within the PDF. Some free tools, like PDFescape or Smallpdf, also offer basic editing capabilities. **How do I convert a Engine Diagram For 1994 Toyota Celica PDF to another file format?** There are multiple ways to convert a PDF to another format: Use online converters like Smallpdf, Zamzar, or Adobe Acrobats export feature to convert PDFs to formats like Word, Excel, JPEG, etc. Software like Adobe Acrobat, Microsoft Word, or other PDF editors may have options to export or save PDFs in different formats. **How do I password-protect a Engine Diagram For 1994 Toyota Celica PDF?** Most PDF editing software allows you to add password protection. In Adobe Acrobat, for instance, you can go to "File" -> "Properties" -> "Security" to set a password to restrict access or editing capabilities. Are there any free alternatives to Adobe Acrobat for working with PDFs? Yes, there are many free alternatives for working with PDFs, such as: LibreOffice: Offers PDF editing features. PDFsam: Allows splitting, merging, and editing PDFs. Foxit Reader: Provides basic PDF viewing and editing capabilities. How do I compress a PDF file? You can use online tools like Smallpdf, I Love PDF, or desktop software like Adobe Acrobat to compress PDF files without significant quality loss. Compression reduces the file size, making it easier to share and download. Can I fill out forms in a PDF file? Yes, most PDF viewers/editors like Adobe Acrobat, Preview (on Mac), or various online tools allow you to fill out



forms in PDF files by selecting text fields and entering information. Are there any restrictions when working with PDFs? Some PDFs might have restrictions set by their creator, such as password protection, editing restrictions, or print restrictions. Breaking these restrictions might require specific software or tools, which may or may not be legal depending on the circumstances and local laws.

### **Find Engine Diagram For 1994 Toyota Celica :**

[mark d eddy mission president](#)

[manager transition plan template](#)

**maps that lie**

**macy's scavenger hunt**

**male pig anatomy**

~~macro financial analysis~~

**maintenance pm template**

[lymph node medulla](#)

[mario peace sign](#)

~~marine diesel engineering~~

*magnolia mac and cheese recipe*

[magruder's government textbook pdf](#)

[lyrics black books nils lofgren](#)

[marching warm up](#)

**m&a insurance due diligence checklist**

### **Engine Diagram For 1994 Toyota Celica :**