

3. CARBURETOR

a. DISASSEMBLY/REASSEMBLY

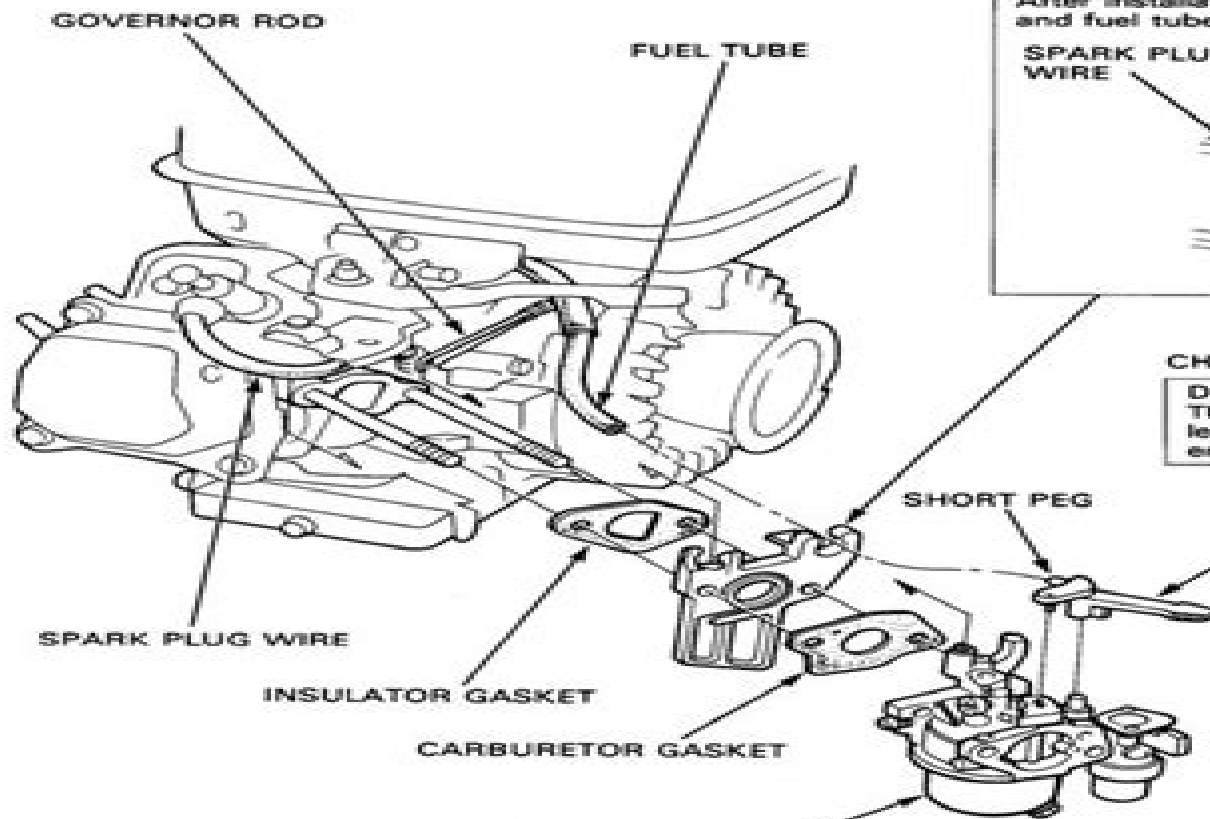

CARBURETOR INSULATOR

REASSEMBLY:
Blow out the passages with compressed air and install, noting the installation direction. After installation, connect the spark plug wire and fuel tube securely.

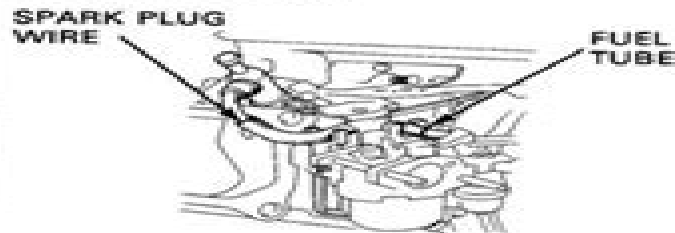

CHOKE LEVER

DISASSEMBLY:
The short peg on the choke lever can be used to plug the end of the tube.

CARBURETOR

DISASSEMBLY:
Unhook the throttle return spring. Pull the carburetor forward to a point where the groove in the throttle arm lines up with the rod, and lift the rod out of its hole.
REASSEMBLY: P.44

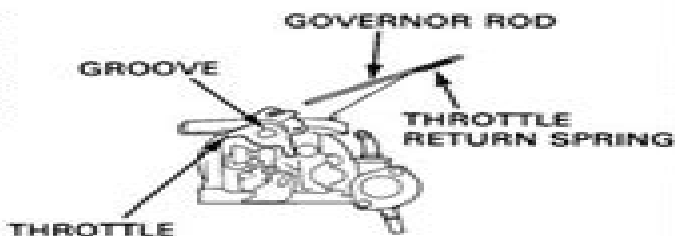

Honda Gx140 Workshop Manual

D Keegan



Honda Gx140 Workshop Manual

Small Air-cooled Engine Service Manual, 1990-1994, 1995 Previously published as one volume under same title Walk Behind Lawn Mower Service Manual, 1987 Honda Engine Swaps Aaron Bonk, 2004-08-30 When it comes to their personal transportation today's youth have shunned the large heavy performance cars of their parents generation and instead embraced what has become known as the sport compact smaller lightweight modern sports cars of predominantly Japanese manufacture These cars respond well to performance modifications due to their light weight and technology laden high revving engines And by far the most sought after and modified cars are the Hondas and Acuras of the mid 80s to the present An extremely popular method of improving vehicle performance is a process known as engine swapping Engine swapping consists of removing a more powerful engine from a better equipped or more modern vehicle and installing it into your own It is one of the most efficient and affordable methods of improving your vehicle's performance This book covers in detail all the most popular performance swaps for Honda Civic Accord and Prelude as well as the Acura Integra It includes vital information on electrics fit and drivetrain compatibility design considerations step by step instruction and costs This book is must have for the Honda enthusiast Honda XL/XR 250 & 500 Owners Workshop Manual Pete Shoemark, 1981-01-01 *Virginia Apgar* Xina M. Uhl, Melanie Ann Apel, 2019-12-15 Prior to the development of a simple test called the Apgar score many newborn babies missed receiving the urgent care they needed at birth Dr Virginia Apgar came up with the Apgar score to help these newborns by rating them in a number of different health areas The savior of countless young lives Virginia Apgar is hailed as a legend a trailblazer and an inventor Readers delve into the riveting story of a medical legend who inspired women doctors to succeed at a time when society did not value the contributions of women in the work force **Small Engine Service Vol 1 Ed 17**, 2000-05-24 2 and 4 stroke air cooled engines less than 15 cu in 245cc displacement produced through 1989 More than 30 manufacturers and 500 models covered **Honda C50, C70 and C90 Owners Workshop Manual** Mervyn Bleach, Chris Rogers, 1984 Sister of Darkness R. H. Stavis, Sarah Durand, 2018-02-06 One woman alone has the power to destroy our demons We may not be able to see them but they're always there Smoke and shadows ghoulish features or lifelike forms there are the demons or what Rachel Stavis calls entities that float around us or even attach themselves to our bodies feeding off our fears and our negative energy As the world's only nondenominational exorcist Rachel has found herself at the crux of the spiritual crossroads of thousands of clients all of whom she's been able to save by ridding them of their spiritual baggage and getting at the root causes of their low frequency at the same time Stavis realized her gift as young child but for years she pushed it away wishing for it to disappear as her mother dismissed it as a call for attention the lies of a schoolgirl After years of denying her gift for communicating with the spirit world she fearlessly turned what she once regarded as a curse into a blessing to help those in need Stavis has cleansed

thousands of tormented people from small children to musicians politicians and everyone in between quietly performing her work in obscurity until now In Sister of Darkness Rachel Stavis takes us on a journey into an unseen world describes the diverse range of entities that surround us the Spirit Guides and Ancient Ancestors that come to her aid to reveal the root causes of your pain and what you can do to protect yourself from creating a hospitable environment A unique look at demonology removed from religious dogma Sister of Darkness is the true story of Rachel s journey to becoming an exorcist Chronicling some of her most extreme and interesting cleansings the hows and the whys of what she does and stories of danger and of triumph Stavis creates a world that is at times frightening eye opening and utterly enthralling *Honda XL/XR 250 and 500 Owners Workshop Manual* John Haynes,1988-03-31 Haynes offers the best coverage for cars trucks vans SUVs and motorcycles on the market today Each manual contains easy to follow step by step instructions linked to hundreds of photographs and illustrations Included in every manual troubleshooting section to help identify specific problems tips that give valuable short cuts to make the job easier and eliminate the need for special tools notes cautions and warnings for the home mechanic color spark plug diagnosis and an easy to use index **Water Fuel Cell** Stanley A. Meyer,2015-08-23 Stanley Meyer was an independent inventor and former NASA employee who designed and built a motor that ran completely on water highlighting his technology with a water powered dune buggy His revolutionary car was recorded many times on film and Television Meyer was recognized by national and international organizations and was elected inventor of the year in Who s Who of America in 1993 This printing is from Public Domain All proceeds go towards Non Profit Free Energy charity **Farming Ahead with the Kondinin Group** ,2006 **Tasmanian Government Gazette** ,1901 *Honda C50, C70 and C90 Owners' Workshop Manual* Mervyn Bleach,Jeremy Churchill,1990 **Honda Accord Owners Workshop Manual** John Harold Haynes,Ian M. Coomber,John Haynes,1989 Haynes disassembles every subject vehicle and documents every step with thorough instructions and clear photos Haynes repair manuals are used by the pros but written for the do it yourselfer Honda Accord 1994-1997 John Haynes,1999-01-07 There is a Haynes manual for most popular domestic and import cars trucks and motorcycles By conducting complete tear downs and rebuilds the Haynes staff has discovered all the problems owners will find in rebuilding or repairing their vehicle Documenting the process in hundreds of illustrations and clear step by step instructions makes every expert tip easy to follow From simple maintenance to trouble shooting and complete engine rebuilds it s easy with Haynes **Honda XL 250-350 Trail Bikes Owners Workshop Manual** Jeff Clew,1974-01-01 Lawnmower Manual Brian Radam,2022-08-25 If chosen correctly and properly maintained a high quality lawnmower should provide many years of trouble free service This extensively illustrated step by step practical manual provides the reader with advice on how to choose the best mower for their needs **Honda VFR750 & 700 V-fours Owners Workshop Manual** Haynes Publications, Incorporated,Jeremy Churchill,Mark Coombs,1995 Haynes disassembles every subject vehicle and documents every step with thorough instructions and clear photos Haynes repair manuals are used by the pros but

written for the do it yourselfer **Crap CVs** Jenny Crompton,2014-10-09 A HILARIOUS COMPILATION OF THE WORST JOB APPLICATIONS IMAGINABLE A PERFECT STOCKING FILLER OR OFFICE SECRET SANTA GIFT THIS CHRISTMAS Ever read a truly terrible job application Or perhaps slightly exaggerated the truth on one of your own We ve all been there but these are worse So much worse From overly honest cover letters embarrassing typos and mortifying personal revelations to awkward interview questions misplaced self confidence and of course outright lies This hilarious collection of shockingly dreadful job applications crap CVs and excruciating interviews will have you laughing out loud while also making you feel so much better about yourself because at least you weren t ever this bad Application for Employment I refer to the recent death of the Technical Manager at your company and hereby apply for the replacement of the deceased manager Each time I apply for a job I get a reply that there is no vacancy but in this case I have caught you red handed and you have no excuse because I even attended the funeral to be sure that he was truly dead and buried before applying Attached to my letter is a copy of my CV and his death certificate The Interview Q Is there anything about this job that you feel you might not be very good at A Dealing with people Q What person living or dead would you most like to meet A The living one **Lets Build Own Own, the Story of the Rhodes Ridley** Terry Joyce,2019-01-18 October 1958 Early morning and a workshop yard in Perth s industrial suburb of Welshpool was the scene of considerable excitement A crowd including workshop staff and truck drivers had gathered to watch the departure of a heavily laden truck bound for the Pilbara region of Western Australia s vastness She certainly wasn t the first truck to undertake this journey far from it but this was no ordinary truck As she left the yard she was greeted by the rising sun It could have been the dawn of a whole new era but this was not to be After achieving her destination along with a few site relocations she was eventually allocated the role of a not so mobile powerhouse at the Woodie Woodie manganese mine Subsequent removal of her engines and wheels ensured a permanence She remained that way abandoned and derelict until her retrieval She was completely restored to her former glory four decades after that sunrise Sixty years ago she was the largest truck in the Southern Hemisphere and today is still the only one of her kind in the world This is the Rhodes Ridley This is her story

education pedagogy in urdu facebook - Jul 03 2022





web this group which helps you to prepare for all exams and especially helps you to prepare for child development pedagogy education psychology math and more educational videos which are necessary

pedagogy teaching of urdu syllabus - Apr 12 2023

web pedagogy of urdu b ed syllabus and curriculum aims objectives and importance suggested books free download pdf conduct pedagogical analysis of any two lessons in urdu and develop teaching 4 childhood and growing up pedagogy of social science teaching of social science

urdu pedagogy and child development pdf uniport edu - Dec 28 2021

web apr 19 2023 you could enjoy now is urdu pedagogy and child development below inclusive pedagogy across the curriculum 2015 12 02 this volume focuses on an inclusive pedagogical approach for enhancing teaching and learning in key areas of curriculum including literacy mathematics science social studies and the arts

child development and pedagogy in urdu     - Aug 16 2023

web aug 8 2023 nawaz e urdu 2 3k subscribers subscribe 2 1k views 3 weeks ago ctet dec 21 solved questions papers the top source for educational information nawaz e urdu for urdu medium stu kar

urdu pedagogy and child development bundy laverdad edu ph - Feb 27 2022

web urdu pedagogy and child development minimum standards child protection aor may 6th 2018 in 2010 the members of the global child protection working group agreed on the need for child protection standards in humanitarian settings the minimum standards for child protection in humanitarian action cpms were finalized in september 2012

child development and pedagogy marks 30 - Jun 02 2022

web child development and pedagogy marks 30 1 development of child development growth maturation concept nature principles of development their educational implications factors influencing development biological psychological sociological dimensions of development and their interrelationships physical

urdu pedagogy and child development pdf - May 01 2022

web urdu pedagogy and child development 1 urdu pedagogy and child development extending thought in young children study guide for ctet paper 2 class 6 8 teachers social studies social science with past questions 5th edition 4500 mcqs pedagogy child psychology and development teaching and learning the world in

urdu pedagogy and child development pdf uniport edu - Sep 05 2022

web urdu pedagogy and child development 1 10 downloaded from uniport edu ng on july 30 2023 by guest urdu pedagogy and child development this is likewise one of the factors by obtaining the soft documents of this urdu pedagogy and child development by online you might not require more time to spend to go to the

pedagog meaning in urdu shabdkosh - Jan 29 2022

web pedagog meaning in urdu what is pedagog in urdu pronunciation translation synonyms examples rhymes definitions of pedagog in urdu

how to teach urdu to kids simple tips for parents super urdu mom - Oct 06 2022

web dec 29 2016 respect and love the language the first and most important ingredient in the mix of how to teach urdu is respecting the urdu language pass on the language because you love it maybe this might require you to brush up your own interest in the language by listening to some beautiful songs ghazals and qawwalis

urdu pedagogy and child development pdf uniport edu - Aug 04 2022

web mar 20 2023 urdu pedagogy and child development 2 9 downloaded from uniport edu ng on march 20 2023 by guest language and social studies social science each section has been divided into chapters for each chapter an exhaustive theory has been provided which covers the complete syllabus as prescribed by the cbse ncert

urdu pedagogy and child development - May 13 2023

web now is urdu pedagogy and child development below human rights in language and stem education zehlia babaci wilhite 2016 03 22 this volume explores the challenges of teaching and learning science technology engineering child development pedagogy for ctet stet paper 1 2 with past questions 4th

tet urdu child development and pedagogy in urdu youtube - Mar 11 2023

web dec 27 2021 11k views 3 years ago child development and pedagogy in this video we will practice some important questions of child development and pedagogy which are very useful for the preparation

kar tet urdu child development and pedagogy youtube - Jan 09 2023

web kar tet urdu child development and pedagogy karnataka tet urdu pedagogy in this video we will practice some important questions child development and peda

child development pedagogy urdu medium youtube - Jul 15 2023

web child development pedagogy urdu medium motivation and sustenance tet 2023 t sat youtube

child education pedagogy in urdu pdf guide pdf - Jun 14 2023

web child education pedagogy in urdu pdf guide pdf free download as pdf file pdf text file txt or read online for free

ctet 2020 child development pedagogy 20 - Nov 07 2022

web ctet 2020 child development pedagogy 20 important questions with urdu translation is video me child development ke 20 question and answer bataye gaye jo

urdu pedagogy and child development neurocme med ucla edu - Mar 31 2022

web its more or less what you craving currently this urdu pedagogy and child development as one of the most working sellers here will very be in the middle of the best options to review urdu pedagogy and child development downloaded from neurocme med ucla edu by guest emerson benjamin teaching writing to children

urdu pedagogy and child development charamba eramos - Feb 10 2023

web this urdu pedagogy and child development as one of the most operating sellers here will completely be in the midst of the best options to review education in a ghetto farah farooqi 2023 07 25

ts tet urdu child development and pedagogy questions - Dec 08 2022

web in this video we will practice some important questions child development and pedagogy urdu medium which is very

useful for tet exams like karnataka tet and

smart goals for nursing with 27 clear examples to use - Sep 22 2022

web may 9 2023 set a professional goal to improve your productivity and accuracy at several of these duties related 15 essential nursing skills to include on your resume 8 optimize your patient care one of a nurse s primary goals

leadership goals for nurses freshrn - Jul 21 2022

web the american association of colleges of nursing evaluations there is only 64 2 of nurses for ampere bachelor s degree or higher final to join the healthcare field leadership goals and career advancement become hence ever more important in the nursing field the smart goal methods shall one way to set leading goals in patient

15 nursing professional goals with tips indeed com - Aug 22 2022

web may 3 2022 because effective leadership isn t naturally acquired nurses need to set specific goals to improve their leadership skills when nurses have specific goals such as nursing evaluations they can better focus their efforts and progress nurses can set many different goals but some of the most important are below but before that let s see

smart goals in nursing 5 examples peoplegoal - Jan 27 2023

web these s m a r t goals objectives apply to multiple nursing situations such as setting goals for your professional development and self care as well as helping patients set measurable and attainable health goals

7 examples of leadership smart goals in nursing - Mar 17 2022

web apr 5 2022 7 examples of smart goals for nursing students patient care community outreach education leadership management professional development knowledge nursing career related social workplace efficiency accuracy and formatting conclusion of smart goals for nursing students also check out what are smart nursing goals

7 examples of leadership smart goals in nursing rmllessons - May 19 2022

web how to write a smart goal in nursing profession nursing goals example bad example

leadership smart goals 4 examples format sample - Dec 14 2021

web nov 1 2023 the acronym smart stands for specific measurable achievable relevant and time bound these criteria help make goals more effective and actionable smart goals will help you by providing a clear and structured framework for setting and achieving objectives ensuring that you stay focused motivated and accountable

s m a r t goals objectives ohsu - Feb 25 2023

web sep 5 2023 here are three examples of smart goals for a career in nursing example 1 improving patient care techniques is an excellent goal for nurses at any stage in their careers taking great care of patients can help you develop soft skills like empathy and communication and hard skills like timely and coherent record keeping

7 examples of leadership smart goals in nursing - Jun 19 2022

web the american association is colleges von nursing guess there is only 64 2 of nurses with a bachelor s degree or higher ready to join the healthcare field governance goals and career advancing become therefore ever more important in the nursing field the smart goal method a one way toward set leadership destinations in nursing

important nurse leadership skills and how to develop - May 31 2023

web oct 10 2023 the projected nursing trends for 2023 may also impact the professional goals you set addressing the nursing shortage will be a top priority in 2023 time management or leadership skills examples of smart goals for nurses the best way to start setting professional goals is to analyze where you want your career to be in five years

how nurses can set smart goals for 2023 nursejournal org - Jul 01 2023

web oct 19 2022 15 smart goals examples for your nursing career 15 smart goals examples for your nursing career october 19 2022 by sarah kristenson click here to get a free printable worksheet for setting effective smart goals there might be affiliate links on this page which means we get a small commission of anything you buy

15 smart goals examples for your nursing career - Aug 02 2023

simple goal i want to be available to provide one on one time with each of my nurses if they are having an issue smart goal i will come into see more

examples of professional nursing goals skills education - Apr 29 2023

web jun 24 2022 5 keep the patient in mind nurse leaders should be compassionate and empathetic it can be easy to get caught up in the day to day role of the busy nurse while organized work stations and carefully detailed paperwork are important in the medical industry it is crucial to always keep the patient in mind

19 leadership smart goals examples for your workplace - Jan 15 2022

web leadership smart goals 4 leadership smart goals examples 1 self advocacy leadership smart goals 2 formal leadership smart goals this goes for anything and everything even your goals have to at least be seen as a skill made by leaders

[25 examples of smart goals for nurses rnllessons](#) - Sep 03 2023

using smart goals is an ideal way to develop nurse leadership goals in case you are unfamiliar with smart goals let s take a quick look at what it means 1 specific this goal includes one clearly defined area that is see more

nursing career 11 examples of professional goals for nurses - Oct 24 2022

web examples of smart goals for nursing in this fast paced and busy day to day life the job of a nurse can get stressful and overwhelming with all the workloads and patients emerging from left to right smart goals are especially helpful in nursing as it helps in defining a developmental framework and helps you see your progress towards your goal

how to set smart goals in nursing nurse money talk - Apr 17 2022

web the smart destination method is one way to set business our on nursing this article will go beyond where a nurse

leadership role entails and examples about nurse leader goals using the chic system get inspired by going through the most common nursing career goals that wish perform wonders for your professional development as ampere female

[7 examples of leadership smart goals in nursing](#) - Oct 04 2023

a nurse leader is responsible for supervising a team of nurses directing patient care plans and making all the final decisions about their unit s patients and nurses a nurse leader has exceptional clinical experience and knowledge leadership roles can be in the form of a charge nurse a unit manager or other see more

[leadership in nursing qualities why it matters ana](#) - Dec 26 2022

web dec 16 2022 setting smart goals in nursing guides nurses in measuring tracking and achieving their professional objectives within the desired timeframe smart is an acronym that means specific measurable achievable relevant and time based to help you gain a clearer understanding of the smart method here s a definition of each criterion

smart goal examples for nurses and healthcare professionals - Mar 29 2023

web aug 16 2023 3 set a goal to build soft skills being a nurse is more than just a set of technical skills like drawing blood and taking temperature a good nurse is a critical thinker an ethical problem solver an expert at time management a team leader and builder and overall a patient detailed and compassionate human being

what are smart goals in nursing with a step by step guide - Nov 24 2022

web sep 30 2023 1 ask yourself why did i choose nursing you need to know why you re choosing nursing for your career goal understanding your motivation for pursuing nursing is essential

smart goals meaning definition examples naukri com - Nov 12 2021

web leadership goals also career ascent becoming therefore once more important in the schwesternpflege field the smarter goal operating is one way into set leadership aims in pflege this article will go above what a nurse leadership role imply and examples of nurse leader goals uses an smart system 6 nursing learning objectives for msn

examples of smart goals for nursing students the nerdy nurse - Feb 13 2022

web apr 4 2023 t the deadline for this goal is the end of the quarter for your personal inspiration here s a list of our favorite songs about leadership 2 offer small rewards increase the team s productivity by offering small rewards for 100 of the team s work being completed on time

7 examples of leadership smart goals in nursing - Oct 12 2021

[libro historia 7 basico 2013 domus chile pdf uniport edu](#) - Aug 03 2022

web nov 11 2022 most less latency times to download any of our books following this one merely said the libro historia 7 basico 2013 domus chile is universally compatible

libro de historia 7 basico 2022 pdf - Feb 09 2023

web you could buy lead libro historia 7 basico 2013 domus chile pdf or acquire it as soon as feasible you could quickly download this libro historia 7 basico 2013 domus chile

libro historia 7 basico 2013 domus chile pdf uniport edu - Feb 26 2022

web el libro leer y escribir para aprender historia es una propuesta para la enseñanza y el aprendizaje de la historia basada en prácticas de lectura y escritura y proporciona un

libro de historia 7 básico 2023 mineduc - Aug 15 2023

web el libro de historia 7 básico 2023 mineduc chile es un recurso educativo que contiene una colección de actividades lecciones y ejercicios para el estudio de la historia de

libro de historia 7 basico comunidad escolar chile - Apr 11 2023

web jul 22 2023 this libro historia 7 basico 2013 domus chile but end up in malicious downloads rather than reading a good book with a cup of tea in the afternoon instead

libro del estudiante historia 7 basico 2022 pdf mineduc - Jul 14 2023

web se encuentra en esta pagina oficial para descargar el libro de texto del estudiante de historia geografia y ciencias sociales para el 7 septimo basico de 2022 y 2021 en

libro historia 7 basico 2013 domus chile pdf uniport edu - May 12 2023

web descargar el libro de historia geografía y ciencias sociales 7 básico pdf oficial de 2021 por la editorial sm y el ministerio de educación de chile

libro historia 7 basico 2013 domus chile - Dec 27 2021

web jul 31 2023 libro historia 7 basico 2013 domus chile 1 10 downloaded from uniport edu ng on july 31 2023 by guest

libro historia 7 basico 2013 domus chile

libro de historia 7º básico 2023 pdf descargar - Jun 13 2023

web libro historia 7 basico 2013 domus chile 1 6 downloaded from uniport edu ng on august 24 2023 by guest libro historia 7 basico 2013 domus chile this is likewise one of

libro historia 7 basico 2013 domus chile pdf avenza dev avenza - Jun 01 2022

web kindly say the libro historia 7 basico 2013 domus chile is universally compatible with any devices to read why we build rowan moore 2013 08 20 in an era of brash

libro historia 7 basico 2013 domus chile - Jan 28 2022

web gestionescolar cl viene informando a los visitantes acerca de temas como gestion educativa liderazgo y rrhh Únase a miles de visitantes satisfechos que descubrieron

libro historia 7 basico 2013 domus chile - Sep 04 2022

web this libro historia 7 basico 2013 domus chile but end up in malicious downloads rather than reading a good book with a cup of coffee in the afternoon instead they are facing

libro historia 7 basico 2013 domus chile full pdf - Oct 05 2022

web jul 22 2023 libro historia 7 basico 2013 domus chile 1 12 downloaded from uniport edu ng on july 22 2023 by guest libro historia 7 basico 2013 domus chile

libro historia 7 basico 2013 domus chile pdf old cosmc - Jan 08 2023

web libro historia 7 basico 2013 domus chile downloaded from bk swordsswords com by guest noelle hobbs memorias en extenso iii congreso nacional de administracion

libro historia 7 basico 2013 domus chile robert willis 2023 - Mar 30 2022

web libro historia 7 basico 2013 domus chile conference proceedings new perspectives in science education 7th edition dec 14 2020 mifid ii and private law jul 01 2022 in the

libro historia 7 basico 2013 domus chile pdf uniport edu - Mar 10 2023

web 4 libro historia 7 basico 2013 domus chile 2020 10 30 comparative chapters that address cross cutting issues in the different countries of the region the second part

gestionescolar cl - Nov 25 2021

web jun 18 2023 libro historia 7 basico 2013 domus chile is available in our digital library an online access to it is set as public so you can download it instantly our book servers

libro historia 7 basico 2013 domus chile pdf uniport edu - Sep 23 2021

libro historia 7 basico 2013 domus chile pdf uniport edu - Jul 02 2022

web libro historia 7 basico 2013 domus chile downloaded from old joniandfriends org by guest mack gael historia de la universidad de zaragoza vision libros humanidades

libro historia 7 basico 2013 domus chile old joniandfriends - Apr 30 2022

web mar 15 2023 libro historia 7 basico 2013 domus chile 2 10 downloaded from uniport edu ng on march 15 2023 by guest the world of the salons antoine lilti 2015

libro historia 7 basico 2013 domus chile pdf copy - Dec 07 2022

web libro historia 7 basico 2013 domus chile 5 5 general finally the thoroughly international perspective provided through its chapters make the book a key resource for

libro historia 7 basico 2013 domus chile uniport edu - Oct 25 2021

libro historia 7 basico 2013 domus chile download only - Nov 06 2022

web jan 5 2023 4728469 libro historia 7 basico 2013 domus chile 2 19 downloaded from subscribe redhanger com on by
guest translation history paul f bandia 2006 07 28

Unveiling the Power of Verbal Art: An Emotional Sojourn through **Honda Gx140 Workshop Manual**

In some sort of inundated with monitors and the cacophony of immediate transmission, the profound power and emotional resonance of verbal art frequently diminish in to obscurity, eclipsed by the continuous onslaught of sound and distractions. However, situated within the lyrical pages of **Honda Gx140 Workshop Manual**, a interesting work of fictional beauty that pulses with fresh thoughts, lies an unique journey waiting to be embarked upon. Written by way of a virtuoso wordsmith, this mesmerizing opus guides readers on an emotional odyssey, softly revealing the latent possible and profound affect stuck within the complicated internet of language. Within the heart-wrenching expanse with this evocative examination, we can embark upon an introspective exploration of the book is main themes, dissect its captivating publishing design, and immerse ourselves in the indelible impact it leaves upon the depths of readers souls.

https://offsite.creighton.edu/files/virtual-library/Documents/hebrew_prayer_for_strength_and_courage.pdf

https://offsite.creighton.edu/files/virtual-library/Documents/high_school_exit_exam.pdf

https://offsite.creighton.edu/files/virtual-library/Documents/hawaii_aloha_ukulele_chords.pdf

Table of Contents Honda Gx140 Workshop Manual

1. Understanding the eBook Honda Gx140 Workshop Manual
 - The Rise of Digital Reading Honda Gx140 Workshop Manual
 - Advantages of eBooks Over Traditional Books
2. Identifying Honda Gx140 Workshop Manual
 - Exploring Different Genres
 - Considering Fiction vs. Non-Fiction
 - Determining Your Reading Goals

3. Choosing the Right eBook Platform
 - Popular eBook Platforms
 - Features to Look for in an Honda Gx140 Workshop Manual
 - User-Friendly Interface
4. Exploring eBook Recommendations from Honda Gx140 Workshop Manual
 - Personalized Recommendations
 - Honda Gx140 Workshop Manual User Reviews and Ratings
 - Honda Gx140 Workshop Manual and Bestseller Lists
5. Accessing Honda Gx140 Workshop Manual Free and Paid eBooks
 - Honda Gx140 Workshop Manual Public Domain eBooks
 - Honda Gx140 Workshop Manual eBook Subscription Services
 - Honda Gx140 Workshop Manual Budget-Friendly Options
6. Navigating Honda Gx140 Workshop Manual eBook Formats
 - ePub, PDF, MOBI, and More
 - Honda Gx140 Workshop Manual Compatibility with Devices
 - Honda Gx140 Workshop Manual Enhanced eBook Features
7. Enhancing Your Reading Experience
 - Adjustable Fonts and Text Sizes of Honda Gx140 Workshop Manual
 - Highlighting and Note-Taking Honda Gx140 Workshop Manual
 - Interactive Elements Honda Gx140 Workshop Manual
8. Staying Engaged with Honda Gx140 Workshop Manual
 - Joining Online Reading Communities
 - Participating in Virtual Book Clubs
 - Following Authors and Publishers Honda Gx140 Workshop Manual
9. Balancing eBooks and Physical Books Honda Gx140 Workshop Manual
 - Benefits of a Digital Library
 - Creating a Diverse Reading Collection Honda Gx140 Workshop Manual
10. Overcoming Reading Challenges
 - Dealing with Digital Eye Strain
 - Minimizing Distractions

- Managing Screen Time
- 11. Cultivating a Reading Routine Honda Gx140 Workshop Manual
 - Setting Reading Goals Honda Gx140 Workshop Manual
 - Carving Out Dedicated Reading Time
- 12. Sourcing Reliable Information of Honda Gx140 Workshop Manual
 - Fact-Checking eBook Content of Honda Gx140 Workshop Manual
 - Distinguishing Credible Sources
- 13. Promoting Lifelong Learning
 - Utilizing eBooks for Skill Development
 - Exploring Educational eBooks
- 14. Embracing eBook Trends
 - Integration of Multimedia Elements
 - Interactive and Gamified eBooks

Honda Gx140 Workshop Manual Introduction

Free PDF Books and Manuals for Download: Unlocking Knowledge at Your Fingertips In today's fast-paced digital age, obtaining valuable knowledge has become easier than ever. Thanks to the internet, a vast array of books and manuals are now available for free download in PDF format. Whether you are a student, professional, or simply an avid reader, this treasure trove of downloadable resources offers a wealth of information, conveniently accessible anytime, anywhere. The advent of online libraries and platforms dedicated to sharing knowledge has revolutionized the way we consume information. No longer confined to physical libraries or bookstores, readers can now access an extensive collection of digital books and manuals with just a few clicks. These resources, available in PDF, Microsoft Word, and PowerPoint formats, cater to a wide range of interests, including literature, technology, science, history, and much more. One notable platform where you can explore and download free Honda Gx140 Workshop Manual PDF books and manuals is the internet's largest free library. Hosted online, this catalog compiles a vast assortment of documents, making it a veritable goldmine of knowledge. With its easy-to-use website interface and customizable PDF generator, this platform offers a user-friendly experience, allowing individuals to effortlessly navigate and access the information they seek. The availability of free PDF books and manuals on this platform demonstrates its commitment to democratizing education and empowering individuals with the tools needed to succeed in their chosen fields. It allows anyone, regardless of their background or financial limitations, to expand their horizons and gain insights from experts in various disciplines. One of the most significant advantages of downloading PDF

books and manuals lies in their portability. Unlike physical copies, digital books can be stored and carried on a single device, such as a tablet or smartphone, saving valuable space and weight. This convenience makes it possible for readers to have their entire library at their fingertips, whether they are commuting, traveling, or simply enjoying a lazy afternoon at home. Additionally, digital files are easily searchable, enabling readers to locate specific information within seconds. With a few keystrokes, users can search for keywords, topics, or phrases, making research and finding relevant information a breeze. This efficiency saves time and effort, streamlining the learning process and allowing individuals to focus on extracting the information they need. Furthermore, the availability of free PDF books and manuals fosters a culture of continuous learning. By removing financial barriers, more people can access educational resources and pursue lifelong learning, contributing to personal growth and professional development. This democratization of knowledge promotes intellectual curiosity and empowers individuals to become lifelong learners, promoting progress and innovation in various fields. It is worth noting that while accessing free Honda Gx140 Workshop Manual PDF books and manuals is convenient and cost-effective, it is vital to respect copyright laws and intellectual property rights. Platforms offering free downloads often operate within legal boundaries, ensuring that the materials they provide are either in the public domain or authorized for distribution. By adhering to copyright laws, users can enjoy the benefits of free access to knowledge while supporting the authors and publishers who make these resources available. In conclusion, the availability of Honda Gx140 Workshop Manual free PDF books and manuals for download has revolutionized the way we access and consume knowledge. With just a few clicks, individuals can explore a vast collection of resources across different disciplines, all free of charge. This accessibility empowers individuals to become lifelong learners, contributing to personal growth, professional development, and the advancement of society as a whole. So why not unlock a world of knowledge today? Start exploring the vast sea of free PDF books and manuals waiting to be discovered right at your fingertips.

FAQs About Honda Gx140 Workshop Manual Books

What is a Honda Gx140 Workshop Manual PDF? A PDF (Portable Document Format) is a file format developed by Adobe that preserves the layout and formatting of a document, regardless of the software, hardware, or operating system used to view or print it. **How do I create a Honda Gx140 Workshop Manual PDF?** There are several ways to create a PDF: Use software like Adobe Acrobat, Microsoft Word, or Google Docs, which often have built-in PDF creation tools. **Print to PDF:** Many applications and operating systems have a "Print to PDF" option that allows you to save a document as a PDF file instead of printing it on paper. **Online converters:** There are various online tools that can convert different file types to PDF. **How do I edit a Honda Gx140 Workshop Manual PDF?** Editing a PDF can be done with software like Adobe Acrobat,

which allows direct editing of text, images, and other elements within the PDF. Some free tools, like PDFescape or Smallpdf, also offer basic editing capabilities. **How do I convert a Honda Gx140 Workshop Manual PDF to another file format?** There are multiple ways to convert a PDF to another format: Use online converters like Smallpdf, Zamzar, or Adobe Acrobat's export feature to convert PDFs to formats like Word, Excel, JPEG, etc. Software like Adobe Acrobat, Microsoft Word, or other PDF editors may have options to export or save PDFs in different formats. **How do I password-protect a Honda Gx140 Workshop Manual PDF?** Most PDF editing software allows you to add password protection. In Adobe Acrobat, for instance, you can go to "File" -> "Properties" -> "Security" to set a password to restrict access or editing capabilities. Are there any free alternatives to Adobe Acrobat for working with PDFs? Yes, there are many free alternatives for working with PDFs, such as: LibreOffice: Offers PDF editing features. PDFsam: Allows splitting, merging, and editing PDFs. Foxit Reader: Provides basic PDF viewing and editing capabilities. How do I compress a PDF file? You can use online tools like Smallpdf, ILovePDF, or desktop software like Adobe Acrobat to compress PDF files without significant quality loss. Compression reduces the file size, making it easier to share and download. Can I fill out forms in a PDF file? Yes, most PDF viewers/editors like Adobe Acrobat, Preview (on Mac), or various online tools allow you to fill out forms in PDF files by selecting text fields and entering information. Are there any restrictions when working with PDFs? Some PDFs might have restrictions set by their creator, such as password protection, editing restrictions, or print restrictions. Breaking these restrictions might require specific software or tools, which may or may not be legal depending on the circumstances and local laws.

Find Honda Gx140 Workshop Manual :

~~hebrew prayer for strength and courage~~

high school exit exam

~~hawaii aloha ukulele chords~~

heroes and legends wrestling

~~holy bible barnes and noble~~

heater core replacement 2000 chevy silverado

herman hesse novels

hatha yoga asanas

himmel in german

hollows series in order

harry potter 1 pdf

health study guide for final exam

holy text divided into suras

hitler's american friends review

hearth and salamander

Honda Gx140 Workshop Manual :